

STONE

Intelligent TFT-LCD Module

Model

STWA121WT-01

Equipment Manual

Contents

Preface	3
1 Introduction	5
2 Technical Parameters	9
3 Interface Description	14
4 Coprocessor (optional)	15
5 Accessories	17
6 Physical Dimensions	19
7 Electrical Components	20
8 Naming Rule	21
9 International Certification	22
APPENDIX	23
Glossary	25

Preface

This equipment manual is part of our Intelligent TFT-LCD Module documentation. It provides the information in regards of operation, installation, configuration, function, system as well as its technical design and working principle.

Organization of the manual

The STWA121WT-01 equipment manual is organized into the following chapters:

Chapter	Contents
1	Overview of features and functional scope of the STWA121WT-01
2-4	Technical Parameters, Interface Description, Coprocessor
5-6	Accessories, Physical Dimensions
7-9	Electrical Components, Naming Rule, International Certification
Appendix	ESD Guidelines, Glossary

Customer Online Services

Customer Support offers comprehensive additional information of Intelligent Products through its Online services as follows:

- Official website: <https://www.stone-hmi.com>
<https://www.stoneitech.com>
- Official forum: <https://forum.stoneitech.com>
- Telephone: 0086-10-84351669

Other support

In need of technical queries, please contact STONE representatives in the subsidiaries and branches responsible for your area.

Trademarks

STONE registered trademarks are as below:

- STONE
- STONE TECH
- Intelligent HMI
- Intelligent TFT-LCD Module
- Smart TFT-LCD Module

Abbreviations

The abbreviation table in this equipment manual is as below:

LED	Light Emitting Diode
CPU	Central Processing Unit
ESD	Electrostatic Sensitive Device
HMI	Human Machine Interface
IF	Interface
LCD	Liquid Crystal Display
UART	Universal Asynchronous Receiver/Transmitter
COM	Commercial
DI	Data Input
DO	Data Output
VIN	Voltage Input
GND	Ground
TP	Touch Panel

A list of all the technical terms together with their explanations is provided in the glossary at the end of this manual.

1 Introduction

This chapter contains general information of:

- Brief Introduction
- Warranty
- Product Characteristics
- Application Area
- Working principle
- Operation Processing
- Software Operation

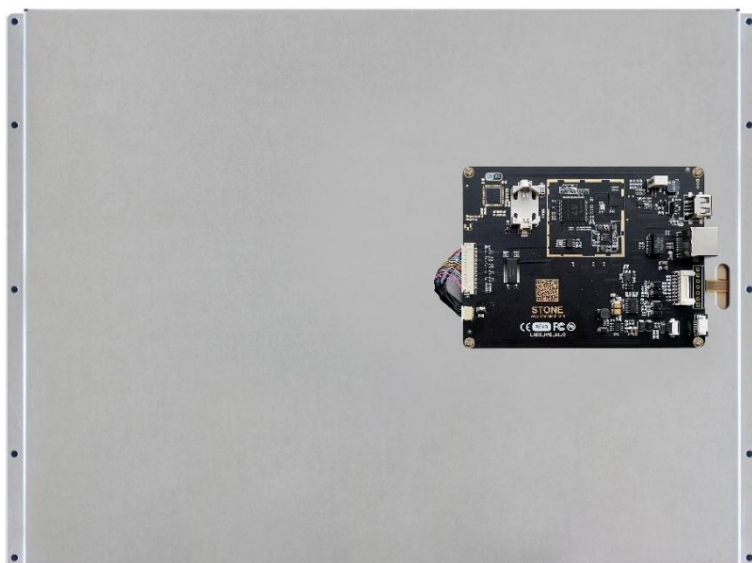

1.1 Brief Introduction

The STWA121WT-01 has been used as **Equipment TFT display & Touch controller**. It includes processor, control program, TFT driver, flash memory, UART port, touch screen, power supply etc., and the important is it can supply the Json Code & Hex Code instruction sets, **so that it can be controlled by Any MCU**.

The STWA121WT-01 can perform all basic functions, such as **Vector font** display, image display, curve display as well as touch function, Video & Audio function etc. The User Interface can be more abundant and various. And the flash memory can store your data, configuration files, image file, font file, video file and audio file etc.

1.2 Warranty

The warranty period is **3 Years** after delivery. Should there be any technical or quality problem within the warranty period, we guarantee the product can be **replaced by a brand-new one unconditionally**, except human broken.

1.3 Product Characteristics

- With Cortex A8 CPU / 256MB Flash / TFT Driving device
- Controlled by any MCU via Json & Hex Code Instruction
- Display Image / Text / Curve / Video
- 262K (18bit) colour TFT display
- With / without Touch Screen
- RS232 / RS422 / RS485 / TTL UART Interface & USB port Downloading
- Ethernet port / WIFI remote control
- Wide voltage range / Strong Working Temperature
- Easy to use! Powerful function! Saving Much Development cost and time!

1.4 Application Area

Widely used in various industrial field

- Medical & Beauty Equipment
- Engineering Machinery and Vehicle Equipment
- Electronic Instrument
- Industrial Control System
- Electric Power Industry
- Civil Electronic Equipment
- Automation Equipment
- Traffic Field
- New Energy Project
- IOT Applications

Etc.

1.5 Working Principle

The Intelligent TFT-LCD Module communicates with the Customer's MCU / CPU / FPGA / PLC via JSON Code and HEX Code Instructions, then the MCU can control its connected equipment to work according to the received instructions.

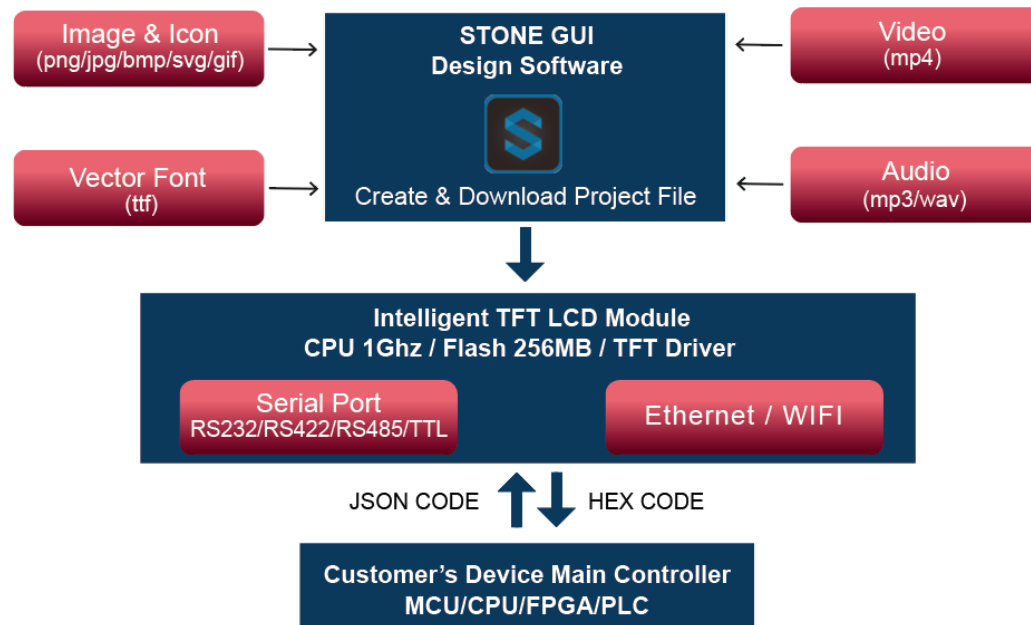

Figure 1.3-1 Configuration and process control phase

1.6 Operation Processing

Only **3 steps** to operate our TFT-LCD Module:

- 1) Build a new GUI project by STONE GUI Designer Software.
- 2) Connect with customer's MCU through RS232,RS422,RS485,TTL directly, Plug & Play.
- 3) Write a simple program for MCU to control the TFT-LCD Module via Instruction Sets.

The communication protocol is built with 2 parts:

1) Initiative Instruction - JSON Code (MCU→TFT-LCD Module)

Frame header	instruction code	widget type	widget name	data	Frame tail
ST<	{"cmd_code":"set_value",	"type":"label",	"widget":"label2",	"value":5}	>ET

2) Passive Instruction - HEX Code (TFT-LCD Module→MCU)

Frame header	CMD	LEN	DATA	Frame tail	CRC16
53 54 3C	10 62	00 09	6C 61 62 65 6C 3F A1 47 AE	3E 45 54	6C 8B

More information, please refer to the document of Instruction Sets.

1.7 Software Operation

We will offer a simple & powerful "Stone GUI designer" Software to assist you to design the new GUI project for TFT-LCD Module basic on Windows system, MacOS system or Linux system.

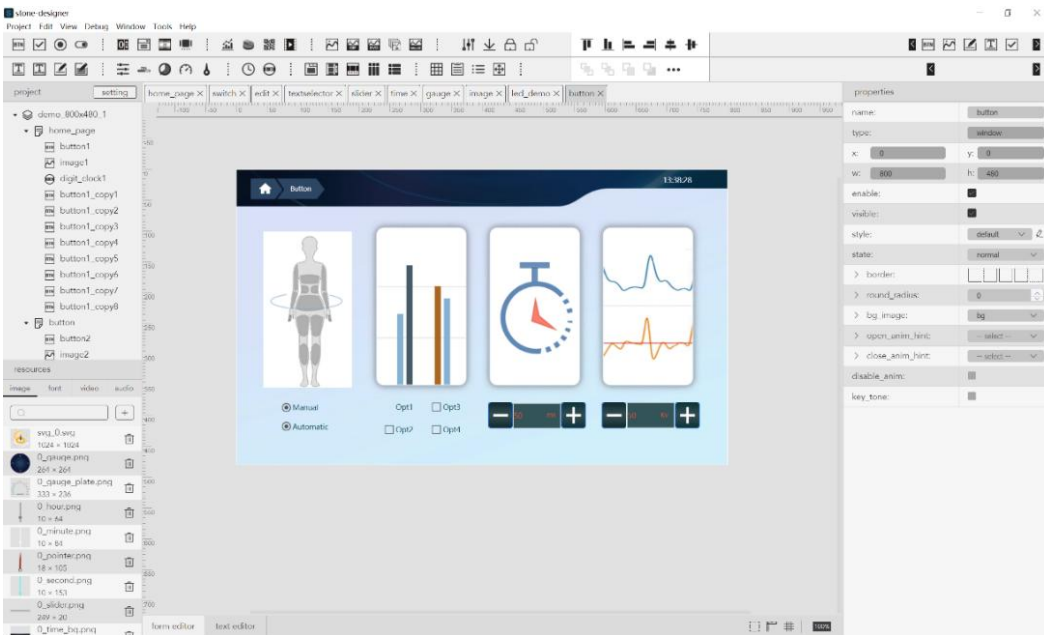
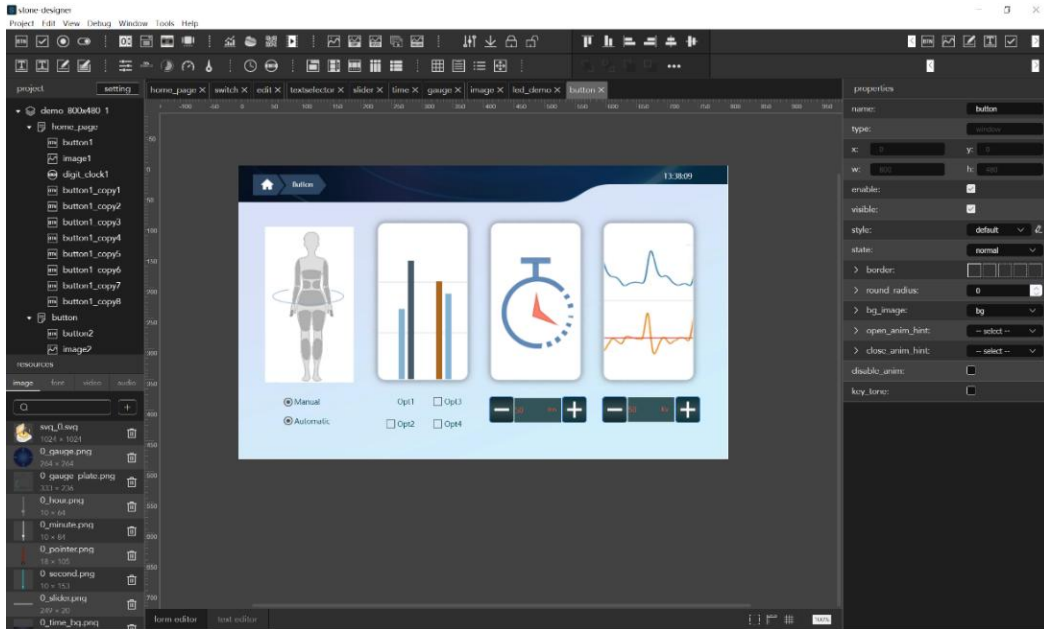

2 Technical Parameters

This chapter contains technical data on:

- **Physical Parameters:**

Physical Parameters

Display

- **Hardware Parameters:**

Processor

Memory

Interface

Power Supply

- **Storage & Test**

Electrical Characteristics

Ambient Conditions

Noise Immunity

Radio Interference

- **Support Device**

Support Device

Technical Parameters

Physical Parameter	
Size	12.1 inch
Resolution	1024×RGB×768
Pixel Spacing	0.1905mm×0.0635mm (H×V)
Color	262,144 colors (18 bit)
Viewing Area	246mm×184.3mm
Display Dimension	288.8mm× 188.1mm
Overall Dimension	279mm×209mm×24.1mm (T) (Standard type) 279mm×209mm×32.7mm (T) (with Ethernet port)
Net Weight	1600g(T)

Display	
Backlight Type	LED
Brightness	500cd/m ² (Brightness can be adjustable in 100 levels)
Contrast	800:1
Backlight Life	30,000 hours
Viewing Angle	88°/88°/88°/88°(L/R/U/D)
TFT Panel	A class industrial TFT Panel
Touch Screen	4-Wire Resistance Touch Screen / Capacitive Touch Screen / Without Touch Screen
Screen Mode:	Digital

Processor	
CPU	Cortex A8
Refresh Rate	1GHz
Max Frame Rate	60 FPS

Memory	
Flash Memory	Standard 256MB
Memory Amount for Image	According to the capability of the image, Support "jpg, bmp, png, svg, gif" format.

Interface	
Serial Interface	RS232 / RS422 / RS485 / TTL level
Ethernet Interface	10M/100M (optional)
Wireless Interface	WIFI (optional)
Project File Downloading	Suggest U Storage Disk or USB2.0 by PC

Power Supply	
Rated Voltage	+12V DC
Permissible Voltage Range	+9V DC...+28V DC
Max. Permissible Transients	+28V
Time between Two Transients	50 sec minimum
Internal Fuse	2A self-recovery fuse
Rated Power	3.0W
Recommended Power Supply	12V, 2A

Electrical Characteristics				
Parameter	Condition	Min	Type	Max
Supply Current	VIN=12V (Max brightness)		370mA	
	VIN=12V (close brightness)		190mA	
Baud Rate	Default		115200 bps	
Static Discharge			EN 61000-4-2	
Contact Discharge/Air Discharge			6 kV/8 kV	

Technical Parameters

Ambient Conditions	
Max. Permissible Ambient Temperature	
Operation	-30°C ~ +80°C
Storage	-40°C ~ +85°C
Relative Humidity	
Operation	55°C, 85%
Storage	60°C, 90%
Shock Loading	
Operation	15 g/11 msec
Storage	25 g/6 msec
Vibration	
Operation	0.035 mm (10 - 58 Hz)/ 1 g (58 - 500 Hz)
Storage	3.5 mm (5 - 8,5 Hz)/ 1 g (8.5 - 500 Hz)
Barometric Pressure	
Operation	706 to 1030 hPa
Storage	581 to 1030 hPa

Noise Immunity	
RF Irradiation	EN 61000-4-3 10 V/m, 80% AM 1 kHz
Pulse Modulation	ENV 50204 900 MHz ± 5 MHz 10 V/meff., 50% ED, 200 Hz
RF Conduction	EN 61000-4-6 150 kHz - 80 MHz 10 V, 80% AM, 1 kHz
Burst Interference	EN 61000-4-4
Supply Lines	2kV
Process Data Lines	2kV
Signal Lines	1kV

Radio Interference	
Radio Interference Level Complying to EN 55011	Class A

Support Device	
UART Port	Support RS232 / RS422 / RS485 / TTL
Network Port	Support(optional) Ethernet Port / WIFI
Flash Memory	Support Standard 256MB
Buzzer	Support
RTC	Support
USB Type A Port	Support Online Download By USB Cable
U Storage Disk Interface	Support Offline Download or Copy User Data
Touch Screen	4 Wire Resistance / Capacitive Touch Screen
Coprocessor	Support(optional) STM32F103C8T6 MCU Chip
Vector Font	Support Standard ttf Format of Computer
Image	Support jpg/bmp/png/svg/gif Format
Video Interface	Support avi / mp4 Format
Audio Interface	Support wav / mp3 Format
Instruction Set	Unified Simplified Instruction Sets

3 Interface Description

This chapter contains the description of the interfaces:

- VIN
- NC
- DO
- DI
- GND

Communication Interface Definition:

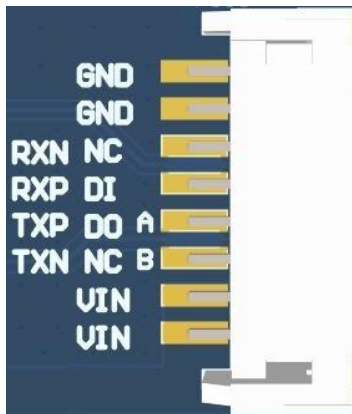

I: Input O: Output P: Power

Option	Pin Name	Pin NO.	Pin Type	Interpret
RS232/ TTL	GND	1,2	P	Power Ground
	DI	4	I	Data Input
	DO	5,	O	Data Output
	NC	3,6		None
	VIN	7,8	P	Power Supply Input
RS485	GND	1,2	P	Power Ground
	A	5	I/O	RS485 A
	B	6	I/O	RS485 B
	VIN	7,8	P	Power Supply Input
RS422	GND	1,2	P	Power Ground
	RXN	3	I	Data Input -
	RXP	4	I	Data Input +
	TXP	5	O	Data Output +
	TXN	6	O	Data Output -
	VIN	7,8	P	Power Supply Input

- Note A:**
- Adopting the 8 Pin 2mm spacing socket. Model Code: A2008WR-S-8P.
 - Direction of the signal was defined with TFT-LCD Module;
 - “I” refers to the signal from the user’s MCU transmitted to the TFT-LCD Module.
 - “O” refers to the signal from the TFT-LCD Module transmitted to the user’s MCU.
 - Pins with the same definition are connected together in the module inside.
 - RS232, TTL, RS422, RS485, port can be default which need to point out in the order.

Note B: The selection of Baud rate for the serial interface:

Baud rate (bps)	1200	2400	4800	9600	19200	38600	57600	115200	921600	1500000
-----------------	------	------	------	------	-------	-------	-------	--------	--------	---------

Serial Port Defind:



- Note A:** RS232 area connect, TTL area disconnect.
TTL area connect, RS232 area disconnect.
- Note B:** The resistance are 0 Ω with 0402 standard package.
- Note C:** The welding pad of STWI035WT-01 is on the back of the PCB, and the black frame needs to be removed .

4 Coprocessor (optional)

This chapter contains the description of the functions:



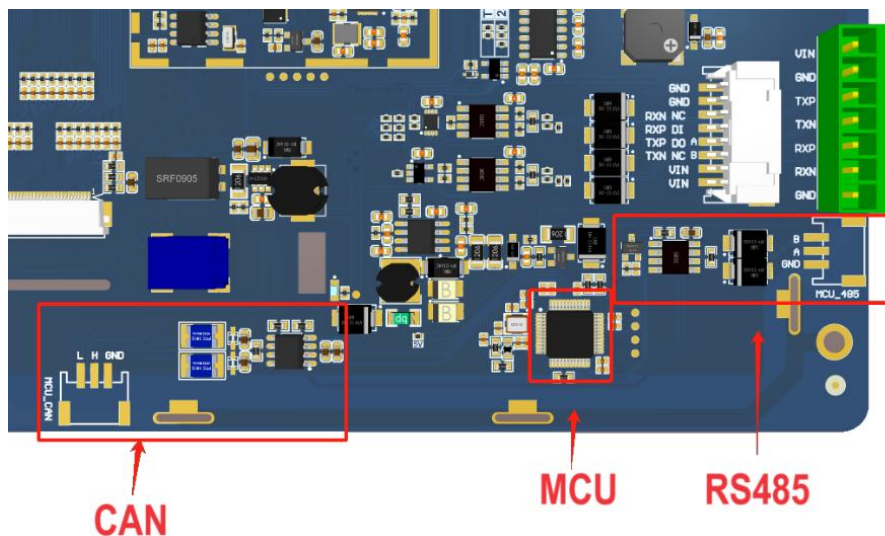
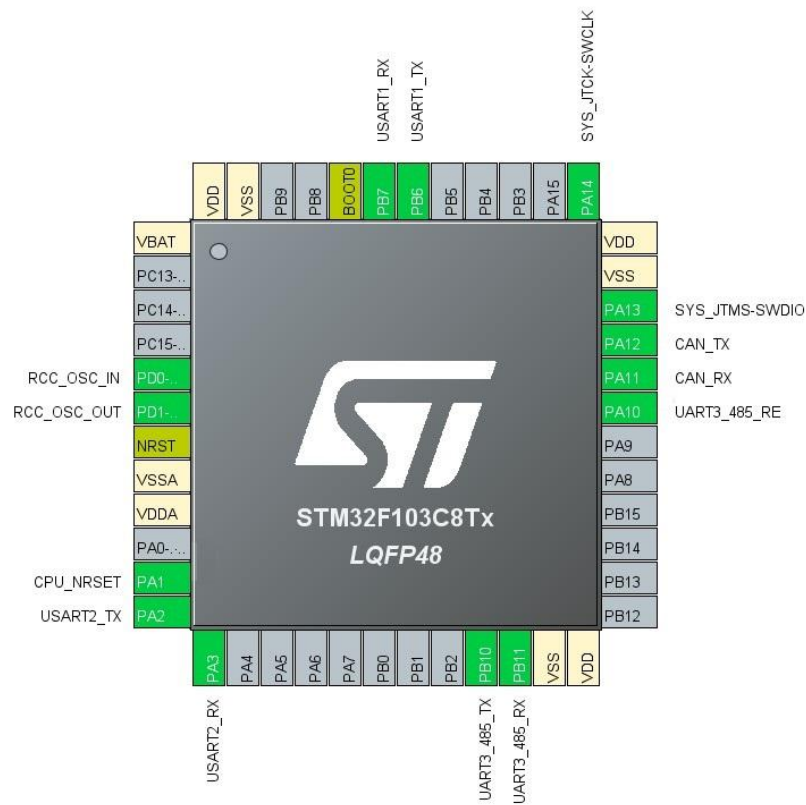

- STM32F103C8T6 MCU Chip
- Instruction Transparent Transmission
- Instruction Translation
- RS485 Bus
- CAN Bus



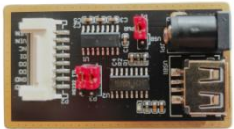

5 Accessories

This chapter contains the accessories:

- Double 8-pin Connect Cable
- 8-pin Socket
- Type A USB Cable
- Converter: USB ⇌ RS232 / RS422 / RS485 / TTL
- IP65 Plastic Box (optional)
- Metal Bezel (optional)

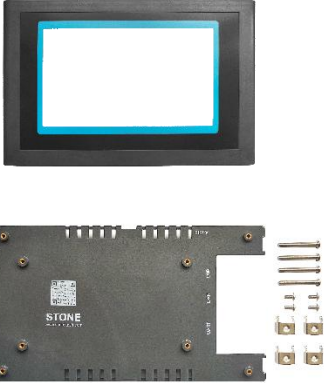
Accessory Name	Model	Note	Picture
Double 8-pin Cable	L8	Optional: 10cm/20cm/35cm/65cm	
8-pin Socket	S8	SMD-8 2.0mm with Lock Model:A2008WR-S-8P	
Type A USB Cable	LU	Double USB Port Cable Online Downloading	
Converter	UR2.0 UR4.0 UR1.0	USB to RS232 USB to RS422 / RS485 USB to TTL	
U Storage Disk		Offline USB Batch Downloading Function	

Accessory Name	Model	Note	Picture
IP65 Plastic Box (optional)	IP65-043 IP65-050 IP65-056 IP65-070 IP65-080 IP65-101	For: 4.3", 5", 5.6", 7", 8",10.1"	 <p>The image shows two items: a black plastic bezel with a white rectangular cutout, and a black printed circuit board (PCB) with gold-plated connectors on the right side. The PCB has the word 'STONE' printed on it.</p>
Metal Bezel (optional)	MB-035 MB-043 MB-050 MB-056 MB-070 MB-080 MB-101 MB-104	For: 3.5", 4.3", 5", 5.6", 7", 8",10.1",10.4" Colour: Silver & Black	 <p>The image shows two metal bezels and a set of screws. The top bezel is silver-colored, and the bottom bezel is black. Both have a white rectangular cutout. To the right of the bezels are several screws of different lengths and colors (silver and black).</p>

6 Physical Dimensions

This chapter contains the information of Physical Dimensions.

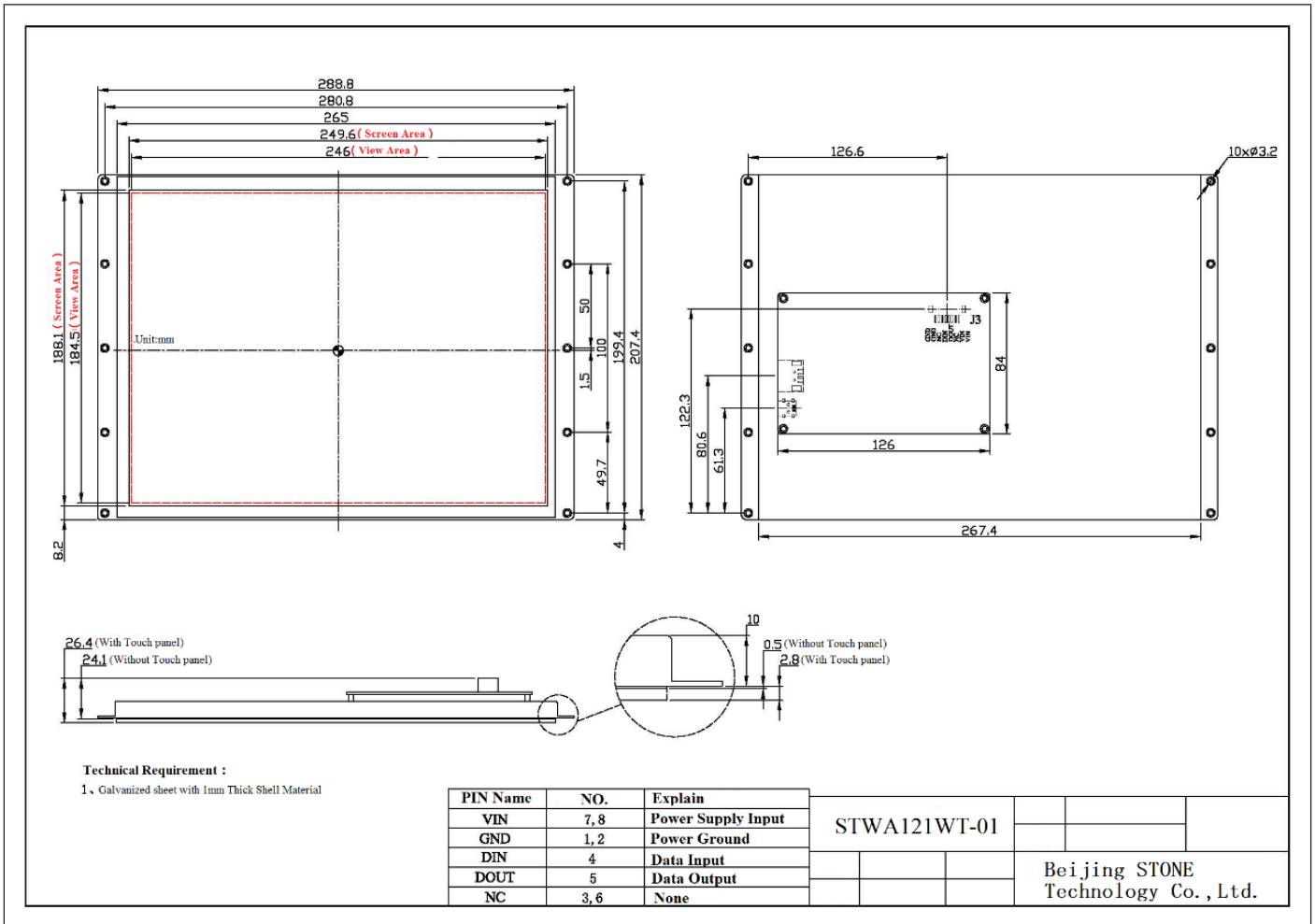

























Figure 6-1 STWA121WT-01 dimension

7 Electrical Components

This chapter contains the brands of the components:

- TFT Panel
- Touch Screen
- CPU
- LCD Controller
- Flash memory
- Connector
- Capacitance
- IC

Components	Supplier			
TFT Panel				
CPU				
LCD Controller				
Touch Screen				
Flash Memory				
Connector				
Capacitance				
IC				

8 Naming Rule

This chapter contains the naming rule:

As sample STWI070WT-01E

Code	Explain
ST	Company Code
W	The third version product
I	I=Industrial Type ; A=Advanced Type; C=Civil Type
070	TFT Panel Dimension: 7 inch
W	W=Wide Voltage (+7V to +28V) L=Low Voltage (+5V)
T	T=With Resistive Touch Screen C=With Capacitive Touch Screen N=Without Touch Screen
0	0=RS232 4=RS422 / RS485 1=TTL Level
1	Hardware Code
E	E=Ethernet W=WIFI

9 International Certification

This chapter contains the certification we passed:

- CE Certificate
- ROHS Certificate
- FCC Certificate
- ISO9001:2008 Quality System

CE Certificate



FCC Certificate



RoHS Certificate



ISO9001:2008



APPENDIX

ESD Guidelines

What does ESD mean?

Virtually all present-day modules incorporate highly integrated MOS devices or components. For technological reasons, these electronic components are very sensitive to overvoltages and consequently therefore to electrostatic discharge:

These devices are referred to in German as Elektrostatisch Gefährdeten Baulemente/ Baugruppen: °EGB°

The more frequent international name is:

°ESD° (E lectrostatic Sensitive D evice)

The following symbol on plates on cabinets, mounting racks or packages draws attention to the use of electrostatic sensitive devices and thus to the contact sensitivity of the assemblies concerned:

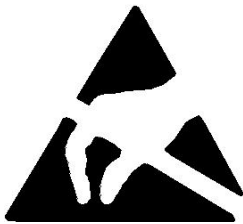

ESDs may be destroyed by voltages and energies well below the perception threshold of persons. Voltages of this kind occur as soon as a device or an assembly is touched by a person who is not electrostatically discharged . Devices exposed to such overvoltages cannot immediately be detected as defective in the majority of cases since faulty behavior may occur only after a long period of operation.

Precautions against electrostatic discharge

Most plastics are capable of carrying high charges and it is therefore imperative that they be kept away from sensitive components.

When handling electrostatic sensitive devices, make sure that persons, workplaces and packages are properly grounded

Handling ESD assemblies

A general rule is that assemblies should be touched only when this cannot be avoided owing to the work that has to be performed on them. Under no circumstances should you handle printed-circuit boards by touching device pins or circuitry.

You should touch devices only if

- you are grounded by permanently wearing an ESD wrist strap or
- you are wearing ESD shoes or ESD shoe-grounding protection straps in conjunction with an ESD floor.

Before you touch an electronic assembly, your body must be discharged. The simplest way of doing this is to touch a conductive, grounded object immediately beforehand ± for example, bare metal parts of a cabinet, water pipe etc.

Assemblies should not be brought into contact with charge-susceptible and highly insulating materials such as plastic films, insulating table tops and items of clothing etc. containing synthetic fibers.

Assemblies should be deposited only on conductive surfaces (tables with an ESD coating, conductive ESD cellular material, ESD bags, ESD shipping containers).

Do not place assemblies near visual display units, monitors or television sets (minimum distance to screen > 10 cm).

Measuring and modifying ESD assemblies

Perform measurements on ESD assemblies only when

- the measuring instrument is grounded ± for example, by means of a protective conductor ± or
- the measuring head has been briefly discharged before measurements are made with a potential-free measuring instrument ± for example, by touching a bare metal control cabinet.

When soldering, use only grounded soldering irons.

Shipping ESD assemblies

Always store and ship assemblies and devices in conductive packing ± for example, metallized plastic boxes and tin cans.

If packing is not conductive, assemblies must be conductively wrapped before they are packed. You can use, for example, conductive foam rubber, ESD bags, domestic aluminum foil or paper (never use plastic bags or foils).

With assemblies containing fitted batteries, make sure that the conductive packing does not come into contact with or short-circuit battery connectors. If necessary, cover the connectors beforehand with insulating tape or insulating material

Glossary



Baud rate

Rate of speed at which data is downloaded. Baud rate is specified in Bit/s.

Boot

A loading process which downloads the operating system in the working memory of the operating unit.



Command Set

Hex Code, the MCU can control the TFT Module via the command set.

Configuration file

It can be created by the softwares.



Download

Download the image, configuration files and data through mini USB port or USB port.

Download mode

Through mini USB port or USB port.



Flash memory

Programmable memory which can be electrically deleted and written to again segment-by-segment.



Half Brightness Life

The period of time after which the brightness tube only achieves 50% of the original value.



Input field

Enables the user to enter values which are subsequently sent to the **MCU**.



MCU

Micro Control Unit, it is widely used in the industrial control.



Normal operation

Operating unit operating mode in which messages are displayed and screens can be operated.



Output field

Displays current values from the **MCU** on the operating unit.



Process screen

The display of process values and process progress on the operating unit in the form of screens, which may contain graphics, texts and values.



RS485

Standard interface for serial data transfer at a very high transmission rate.



Screen

A screen displays all the logically related process data on the operating unit, whereby the individual values can be modified.



Touch panel

This is an operating unit without a keyboard. The touch panel (abbreviated to TP) is operated via the contact-sensitive screen elements.